



客户名称 CUSTOMER		客户品名 CUSTOMER P/N		版别 REV.	A
产品类型 PRODUCT TYPE	Common Mode Line Filter	品名 OURS P/N	HKCM-1005HC-SERIES	文件编号 FILE NO.	HKX210327

## 五. 材料清单 / MATERIAL LIST

NO.	ITEM	DESCRIPTION
1	CORE	FERRITE
2	CASE	DAP
3	WIRE	P180 Grd1
4	SOLDER	Sn99.3:Cu0.7
5	INK	WHITE

## 六. 编带规格 / TAPING SPECIFICATIONS

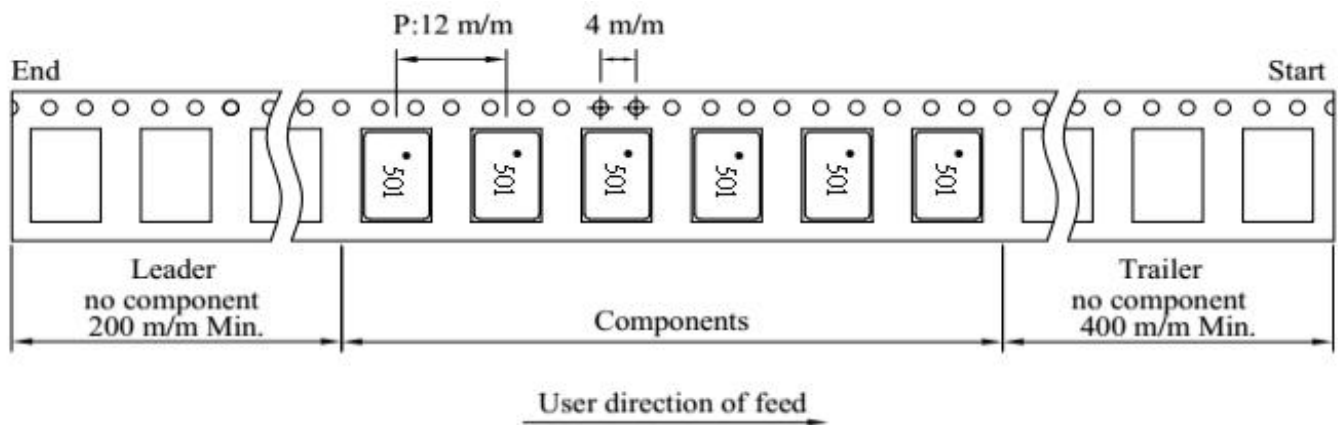

Adhesive strength of cover tape is 20 to 120 gf  
The conduction band direction

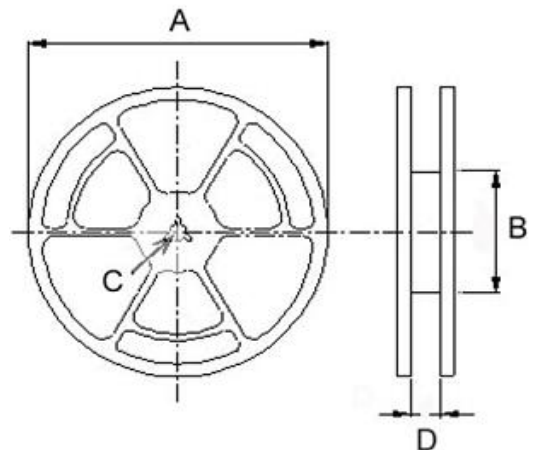
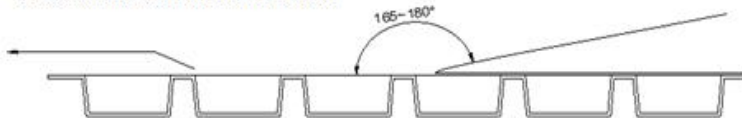

Reel Dimensions (Unit: mm)				Quantity
A	B	C	D	Pcs/Reel
330	100	13	16.5	1000

客户名称 CUSTOMER		客户品名 CUSTOMER P/N		版别 REV.	A
产品类型 PRODUCT TYPE	Common Mode Line Filter	品名 OURS P/N	HKCM-1005HC-SERIES	文件编号 FILE NO.	HKX210327

## 七. 特征曲线/CHARACTERISTICS(REFERENCE)

HKCM-1005HC-501

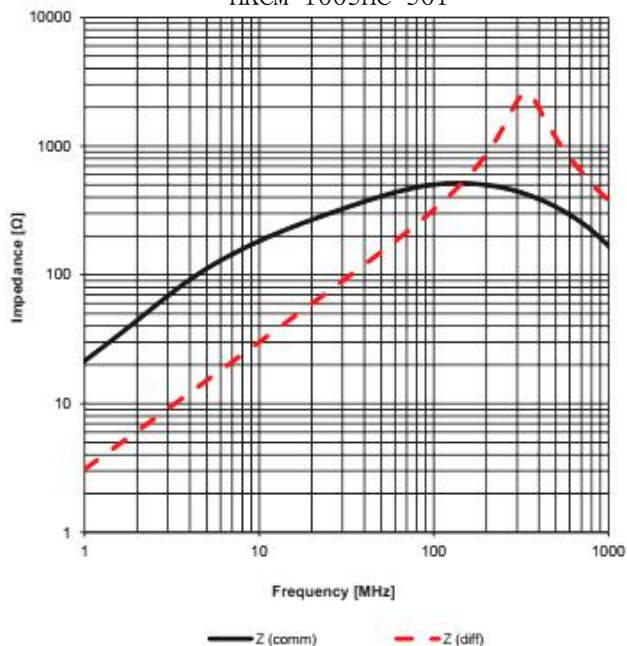

HKCM-1005HC-801

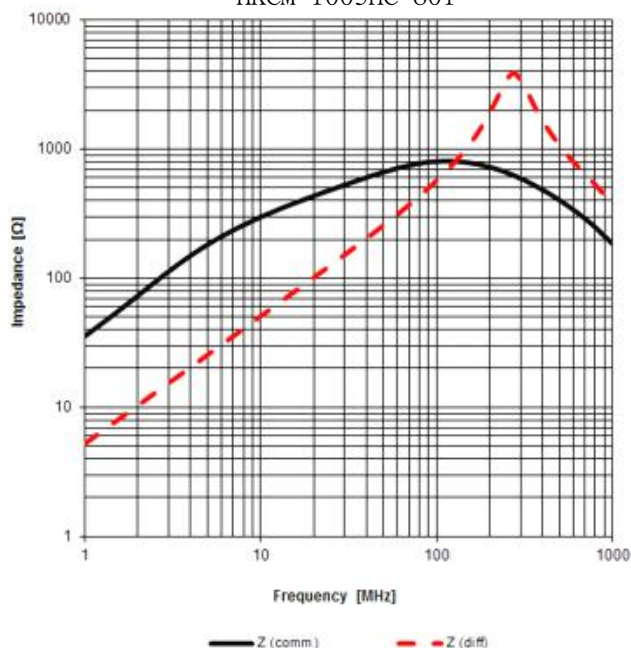

HKCM-1005HC-102

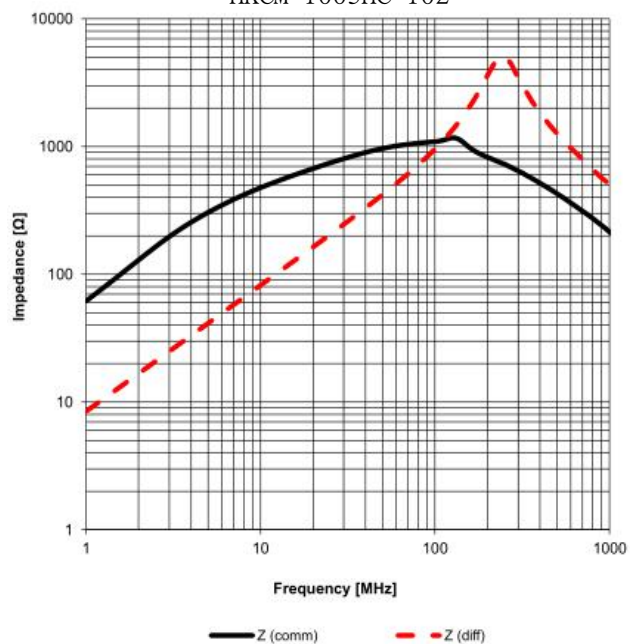

HKCM-1005HC-222

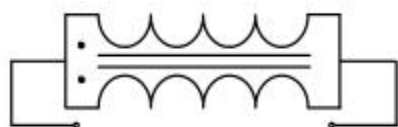
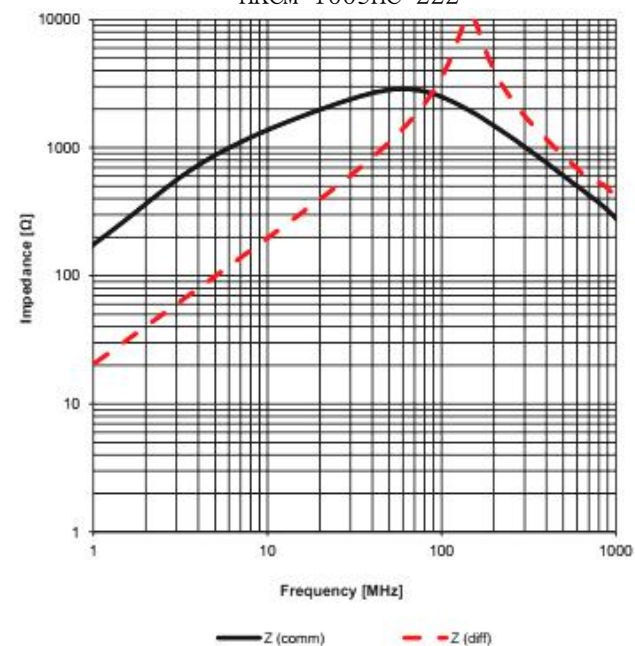

Common Mode

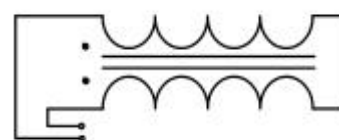

Differential Mode

客户名称 CUSTOMER		客户品名 CUSTOMER P/N		版别 REV.	A
产品类型 PRODUCT TYPE	Common Mode Line Filter	品名 OURS P/N	HKCM-1005HC-SERIES	文件编号 FILE NO.	HKX210327

## 八.可靠性测试/RELIABILITY TESTING

Operating Temperature	- 40 to +125 °C ( Contain Heating coil )
Appearance Inspection	No external defects by visual inspection
Terminal Strength	After soldering , between copper plaet and terminals of coils , push in two directions of X , Y with standing 10N(1.02kg) for10+/-2 sec. Terminal should not peel off. ( Refer to figure at right )
Heat endurance of reflow soldering	Refer to figure
Insulating resistance	Over 100 MΩ at 100V D.C . between wire and core
Dielectric Strength	Apply at 0.5KV 3mA for 1 minute between wire and core
Temperature characteristics	Inductance coefficient ( 0~2,000 ) × 10 / °C ( - 40~ + 125 °C )
Humidity characteristics	Inductance deviation within ± 10% , after 96 hours in 90~95% relative humidity at 40 ± 2 °C and 1 hours drying under normal condi

A test is made under the above mentioned condition , and it is kept for 2 hours in the normal

### IR Reflow profile

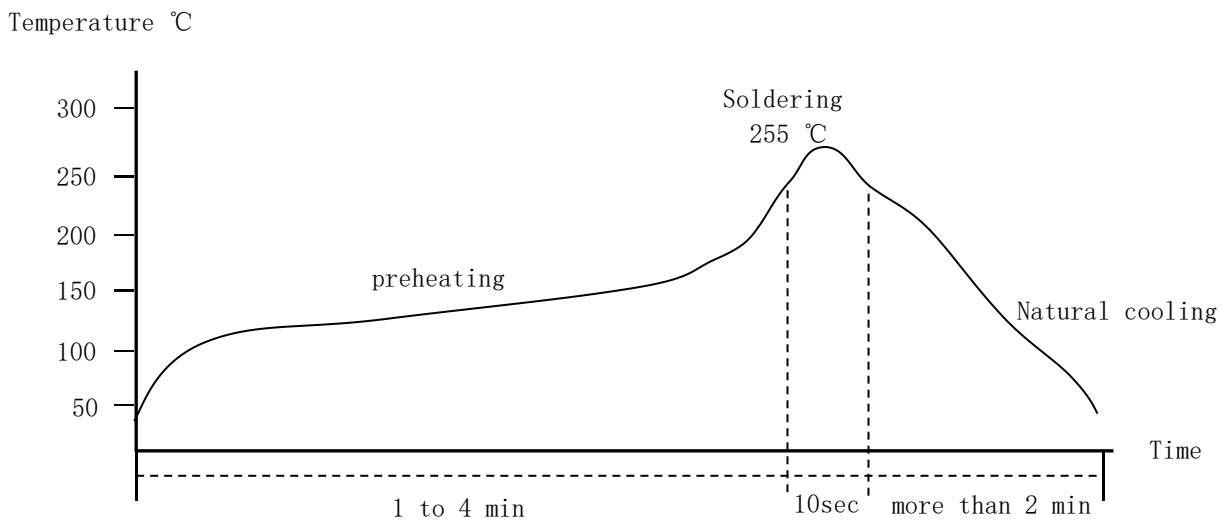

Temperature and humidity . After that , no mechanical and electrical defect should be found

客户名称 CUSTOMER		客户品名 CUSTOMER P/N		版别 REV.	A
产品类型 PRODUCT TYPE	Common Mode Line Filter	品名 OURS P/N	HKCM-1005HC-SERIES	文件编号 FILE NO.	HKX210327

## 九. 包装方式/PACKING LIST

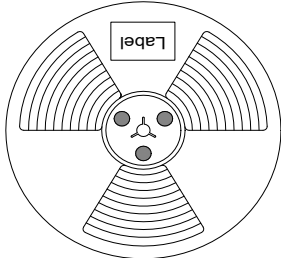
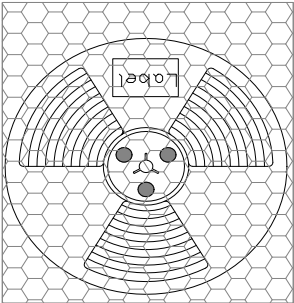
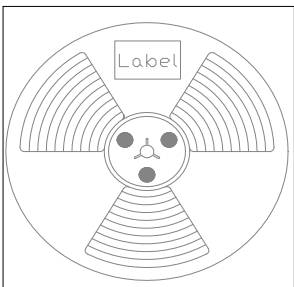
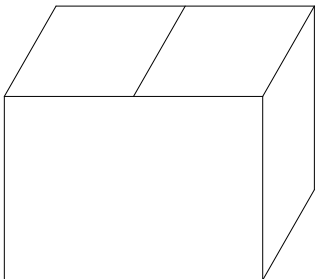
	<p>1、轮盘规格：13(直径330mm) 数量：1000PCS/盘</p>
	<p>2、数量：1000PCS/袋.</p>
	<p>3、数量：3000PCS/盒</p>
	<p>4、数量：15000PCS/箱. 作业说明：当尾数箱不足一整箱时需用内盒或填充物装满.</p>